

Pearl Crystal

# SPA

## INFORMATIONAL PEDICURE SPA DIMENSION SHEET

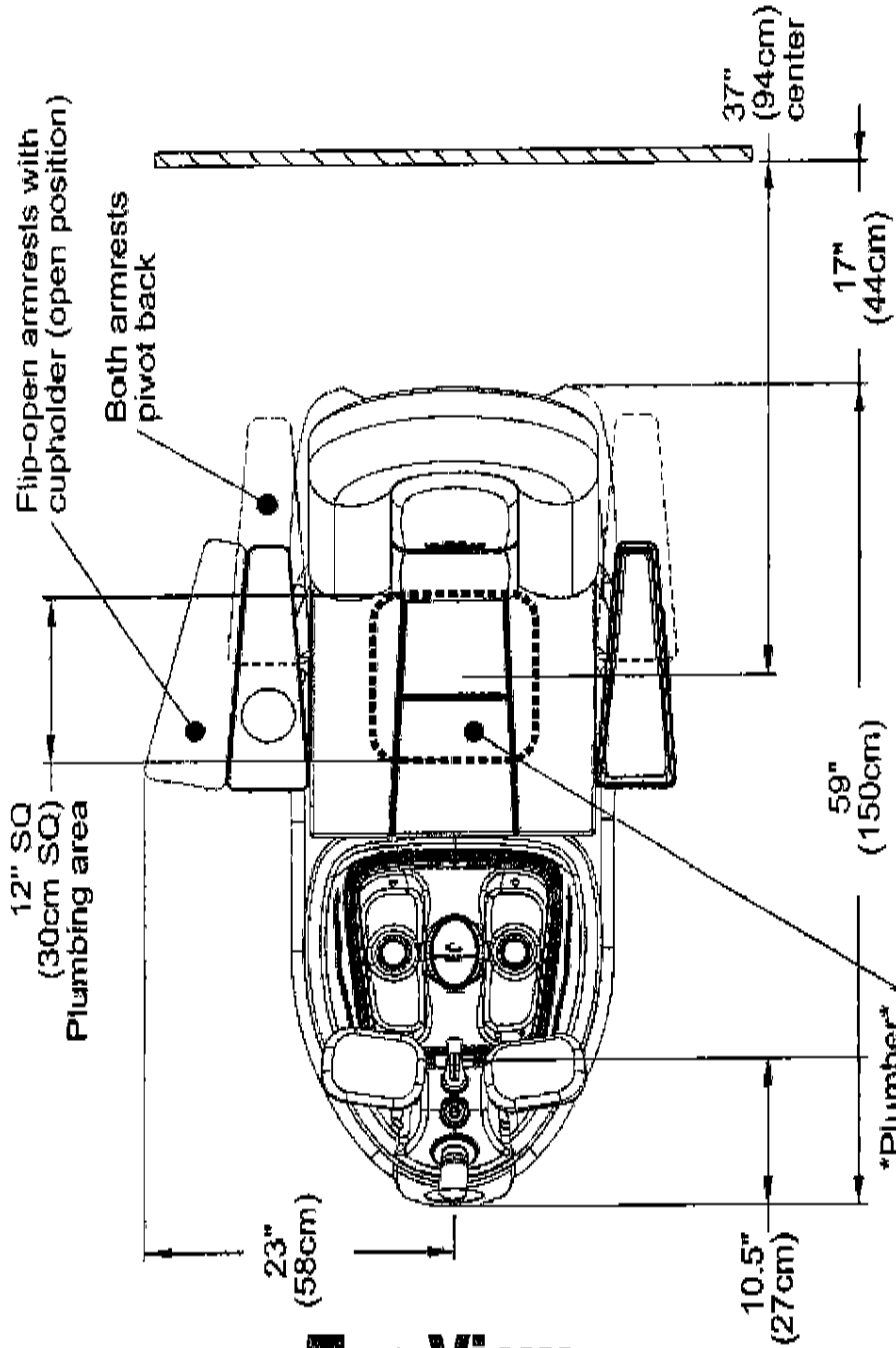

### Top View

**NOTE:** Cutting end off of electrical plug to hardwire the spa is **NOT** recommended. Doing so will void the warranty.

This space may be used for hot & cold supply line rough-ins, if under spa connections are requested. If gravity drain connection is required, power drain pump must be removed and drain plumbed to local plumbing requirements.



Pearl

Crystal

# SPA

## INFORMATIONAL PEDICURE SPA DIMENSION SHEET

### Side View

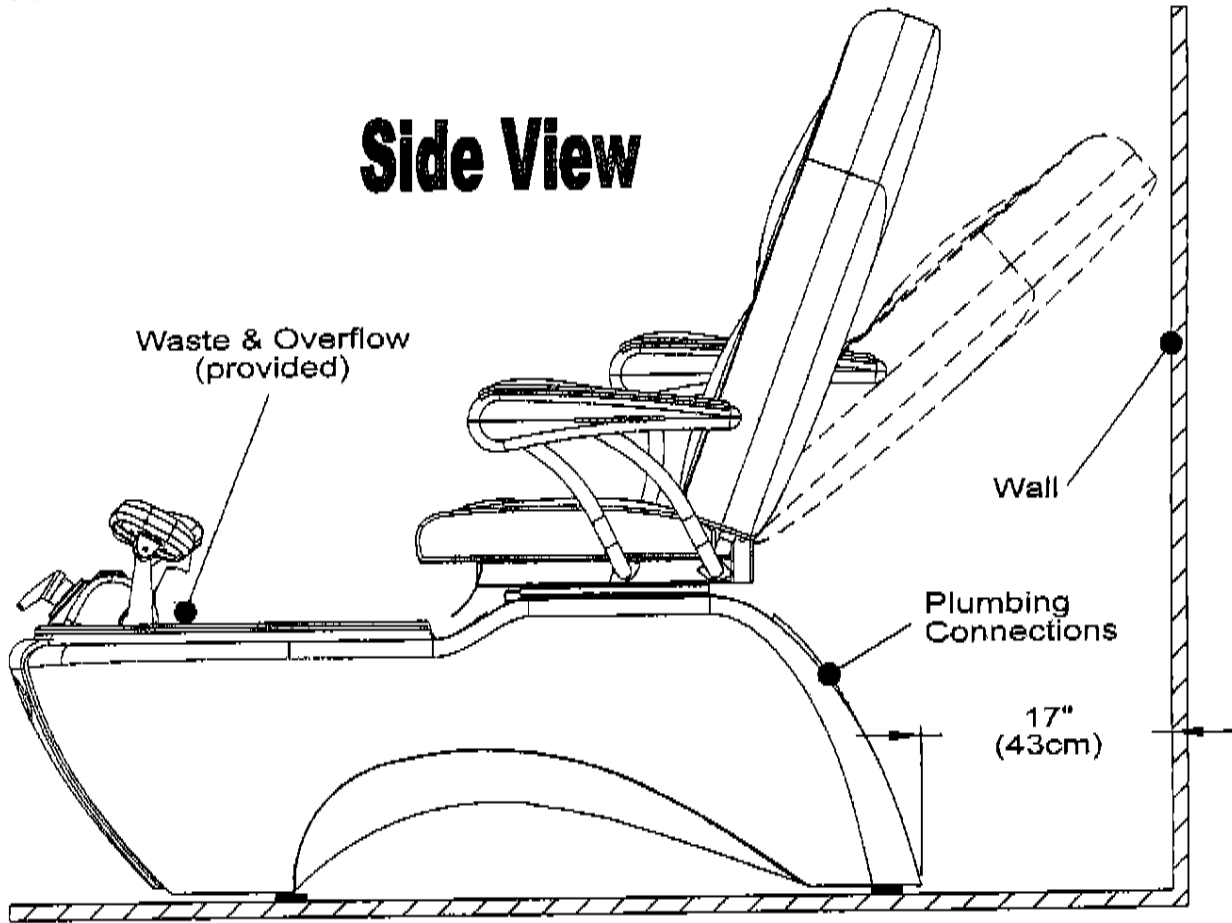

### Plumbing Connections

Direction of Water Flow

### Top View of Plumbing Connections

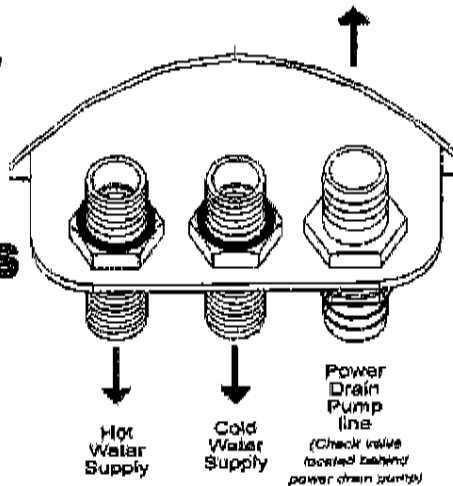

Hot and Cold Water Supply Fittings are 1/2" MHT (male)

Power drain pump drain line 3/4" slip on hose barb

# DIAMOND PEDI-SPA

**Jade Collection Whirlpool Pedicure Spa**  
**Traditional Whirlpool (with Jets) & Crystal Clean™ Pipe-Free**  
**Dimensional Drawings**

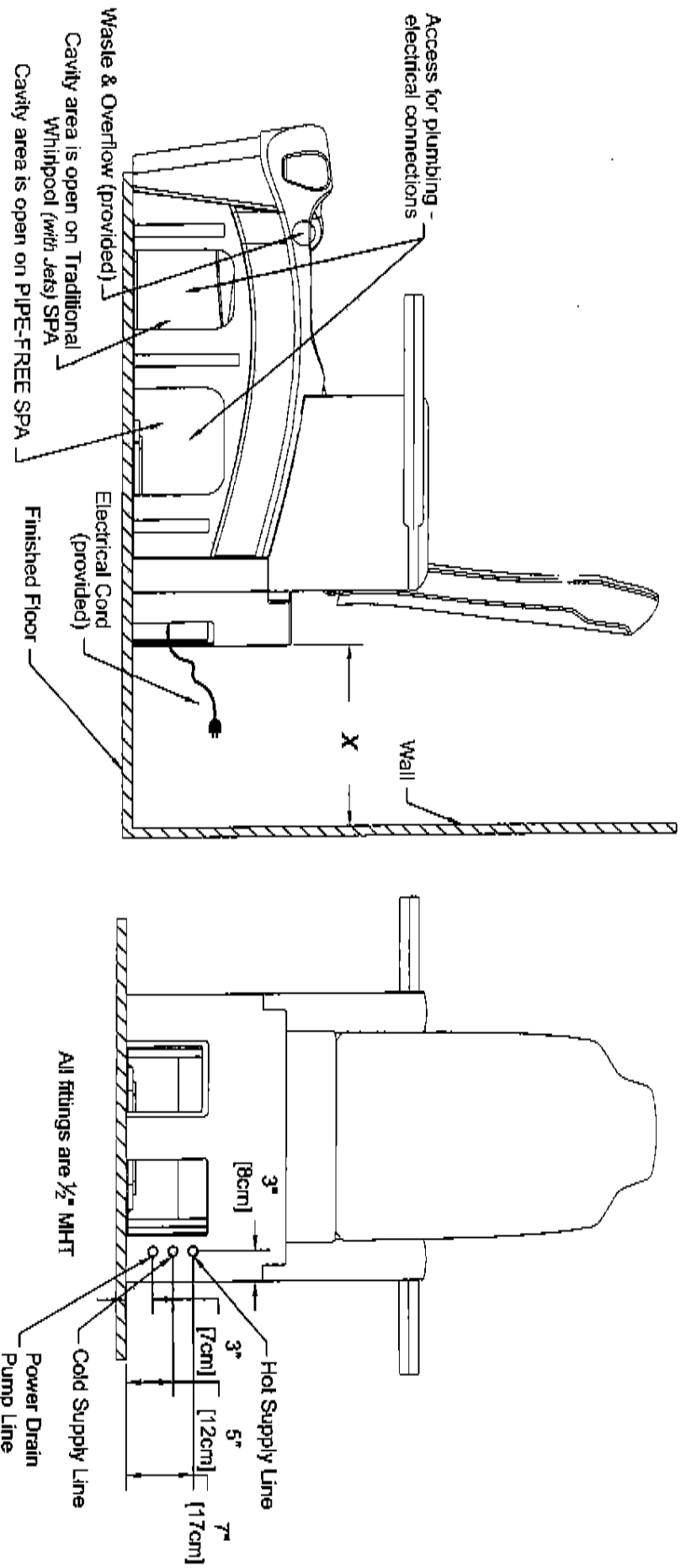

Rev: C

Page 1 of 3

# Wall Drain Installation

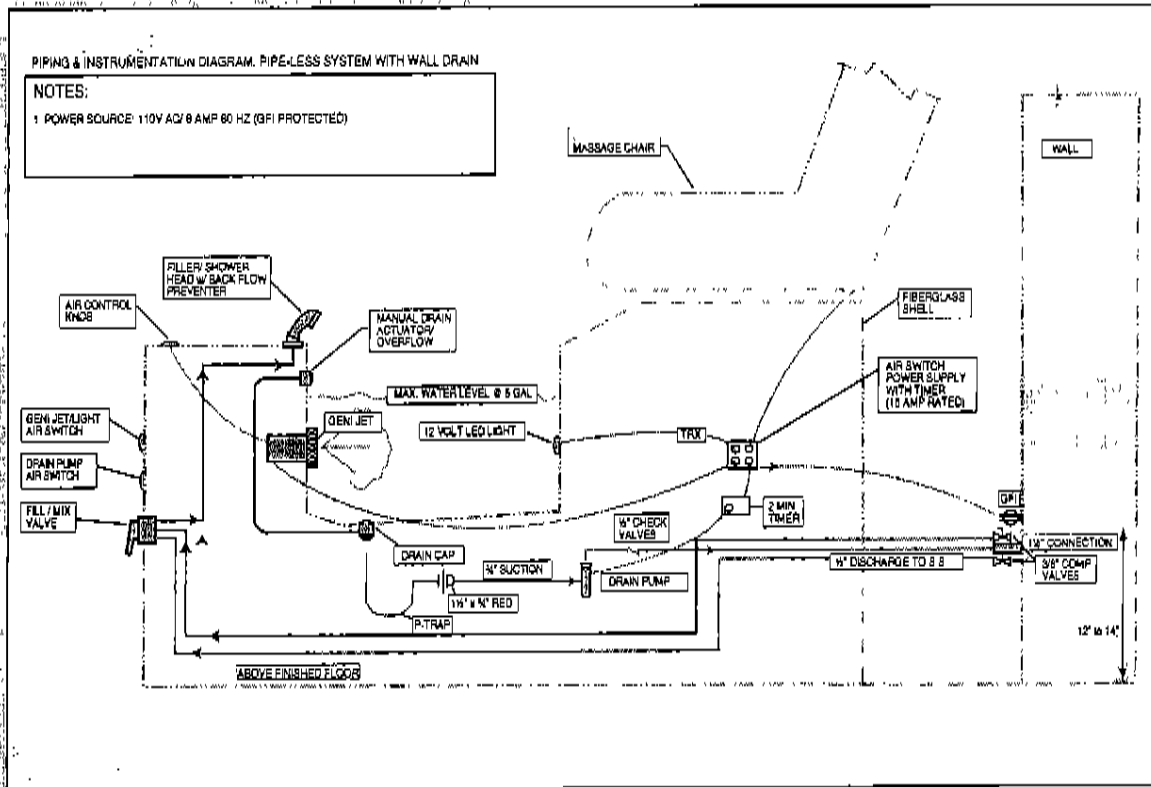

# Gravity Drain Installation

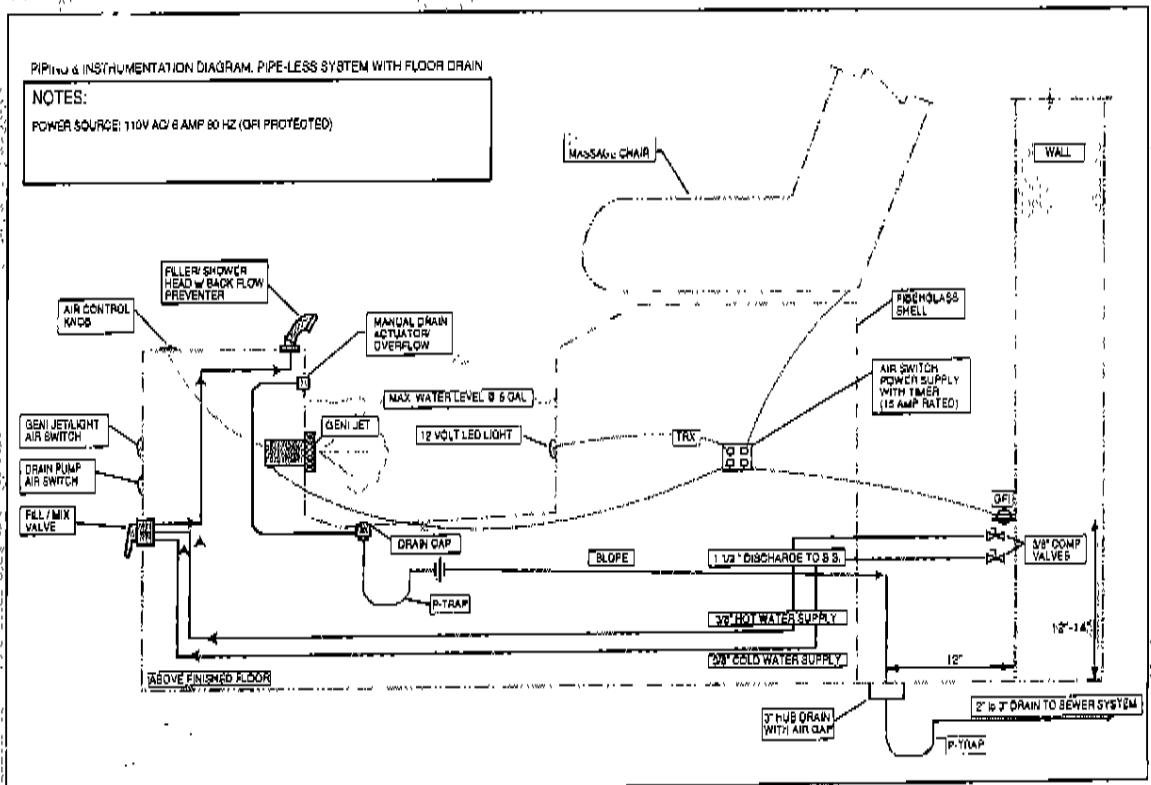

# Parts Identification

## Floor Drain

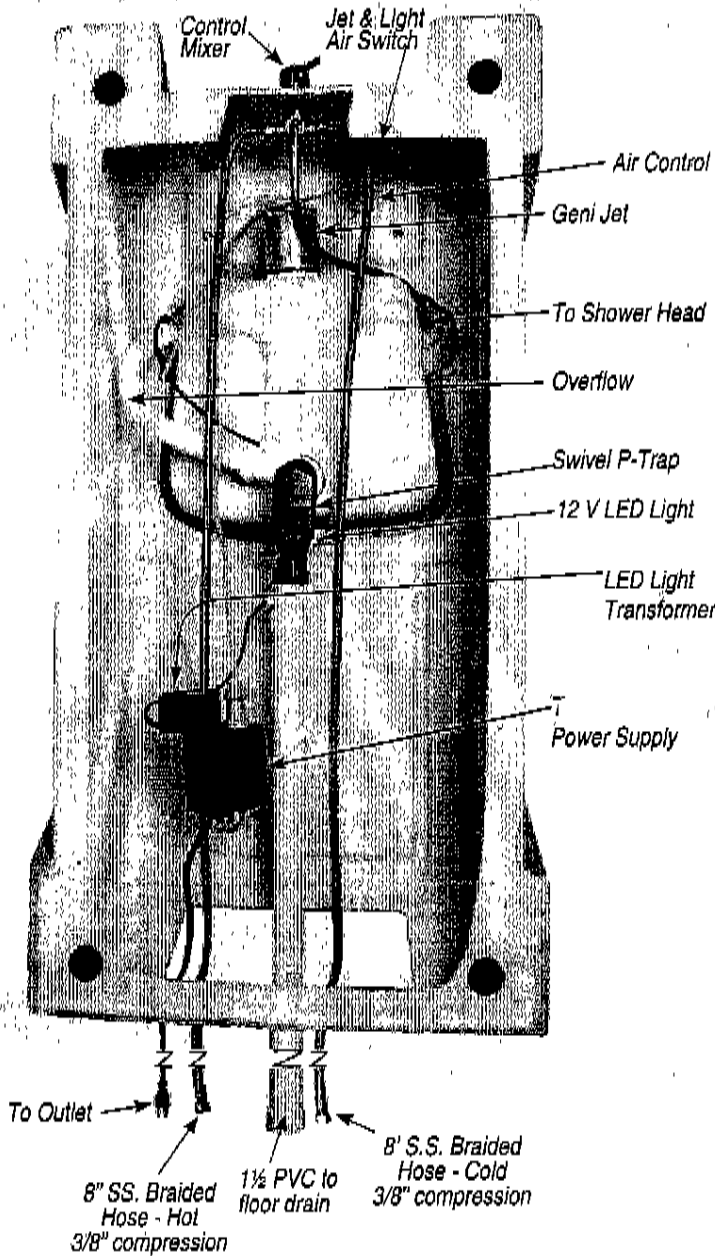

## Wall Drain

